

data buoy platforms

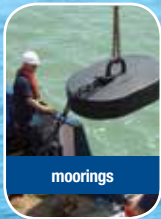

moorings



navigation buoys



hydrosphere



navigation lights



mooring buoys

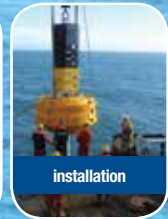

installation

the UK's leading supplier of aids to navigation

# Mobilis AMR 2500-600

## 1.85m-1.24m diameter mooring buoys



MOBILIS

The mid-range AMR series of mooring buoys are suitable for the majority of harbour and coastal applications.

The buoy hulls are made up of two or four rotationally moulded, medium density polyethylene (MDPE) float sections, combined with a galvanised steel central structure. This creates a strong, lightweight buoy capable of supporting substantial loads. The use of polyethylene for the hulls allows the buoys to absorb minor impacts without damage to the buoy or vessel.

Two float sizes are available for the medium-sized range. The larger 1.85m diameter floats form the hull of the AMR 2500 and provide 2500Kg gross buoyancy. The cylindrical or conical 1.24m floats are used for the other smaller models. The buoys' modular design allows for commonality of parts, thereby reducing maintenance, inspection, replacement and spares holding costs. The buoys are supplied in white or yellow as standard. However, other colours are available if required.

A selection of possible mooring point options are available. All of the buoys are available with a D link and static 'T' attachments, whilst the AMR 2500 is also available with quick-release hook and shackle options.



mooring buoys

- features:**
- Suitable for marina, port and coastal applications
  - UV stabilised MDPE components – retains colour within IALA guidelines for more than 15 years
  - Galvanised steel central structure
  - Safe working loads of up to 60 tonnes
  - Modular system - reduces spares holding
  - Multiple mooring attachments
  - Up to 1.85m diameter
  - Up to 2500Kg gross buoyancy

### mooring configurations



aquaculture | marinas & sailing clubs | ports & harbours | offshore renewable energy | oil & gas

t: +44 (0)1420 520374    www.hydrosphere.co.uk    e: sales@hydrosphere.co.uk

# Mobilis AMR 2500-600

## specifications and applications

construction	AMR 2500	AMR 2000	AMR 1500	AMR 1000	AMR 600
Central Structure	Galvanised steel				
Hull	MDPE (2 or 4 float sections)				
<b>physical</b>					
Diameter m	1.85	1.24	1.24	1.24	1.24
Height m	3.5	2.9	2.9	2.0	2.1 / 1.5
Weight Kg (inc. shackles)	950	300	280	250	185
Safe Working Load Tonnes	60 / 20	12	12	12	12
Draft m	1.9	1.2	1.2	0.9	0.7 / 0.6
Max Current Knots	11	11	11	8	8
Gross Buoyancy Kg	2500	2000	1500	900	600

### mooring

Quick-release Hook	✓				
Shackle	✓				
Static 'T'	✓	✓	✓	✓	✓
D Link	✓	✓	✓	✓	✓

### application

Deep Sea					
Estuary	✓	✓	✓	✓	✓
Coastal	✓	✓			
Ports	✓	✓	✓	✓	✓
Rivers	✓	✓	✓	✓	✓

AMR 2500 with shackle

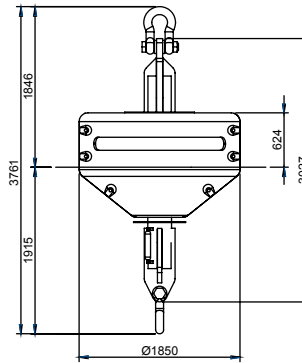

AMR 2000 with D link

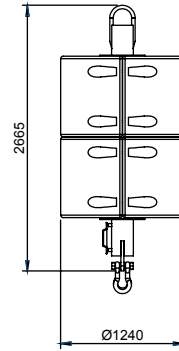

AMR 1500 with D link

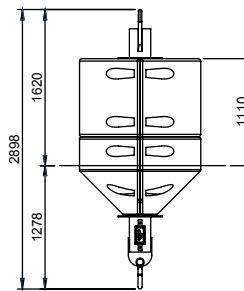

AMR 1000 with static 'T'

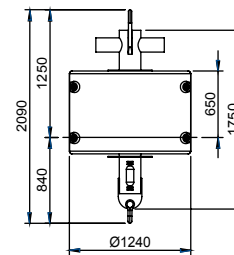

AMR 600 with D link

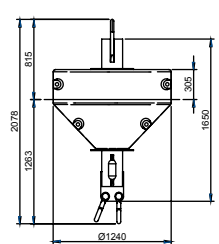

## the right mooring buoy for the job

The mooring buoy, chain and sinker / anchor should be considered a complete system; we can offer a mooring and buoy design service to ensure the correct buoy and mooring are supplied.



**hydrosphere**

### about Hydrosphere

Hydrosphere is the UK's leading supplier of aids to navigation and has been providing cost-effective solutions to the marine industry for more than 20 years. We offer a wide range of navigation and mooring buoys, LED navigation lights, sector lights, rotating beacons, leading lights, jetty masts, beach and zone marking products and associated moorings. Rental, installation and maintenance services are also available for all our products and systems.

For more information please contact us.

data buoy platforms | moorings | navigation buoys | navigation lights | mooring buoys | installation

t: +44 (0)1420 520374

www.hydrosphere.co.uk

e: sales@hydrosphere.co.uk

Compliant with all IALA recommendations.

